

MRS110.16

Diodes module

Features:

- International standard package
- Low forward voltage drop
- Isolation voltage 3000V ~
- Simple mounting
- UL recognized, file no. E312789



Typical applications:

- Various rectifier power
- AC/DC motor control
- Heater control
- Frequency converters

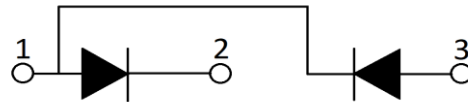

Symbol	Characteristics	Test Conditions	Value			Unit
			Min	Typ	Max	
$V_{RSM/DSM}$	Non-repetitive reverse/forward blocking voltage	$T_j = 25^\circ\text{C}$			1700	V
$V_{RRM/DRM}$	Repetitive reverse/forward blocking voltage	$T_j = 25^\circ\text{C}$			1600	V
$I_{F(AV)}$	Forward average current	180° half sine wave 50Hz $T_c = 100^\circ\text{C}$			110	A
$I_{F(RMS)}$	Forward square root current	180° half sine wave 50Hz $T_c = 100^\circ\text{C}$			158	A
I_{RRM} I_{DRM}	Repetitive peak current	at V_{DRM}/V_{RRM} $T_j = 150^\circ\text{C}$			5	mA
I_{FSM}	Forward surge current	10ms half sine wave, $T_j = 45^\circ\text{C}$			2800	A
$I^2 t$	$I^2 t$ for fusing coordination	$V_R = 0.6 V_{RRM}$, $T_j = 45^\circ\text{C}$			39200	A ² s
V_{FO}	Threshold voltage	$T_j = 150^\circ\text{C}$			0.85	V
r_T	Forward slope resistance	$T_j = 150^\circ\text{C}$			1.50	mΩ
V_{FM}	Peak forward voltage	$T_j = 25^\circ\text{C}$; $I_F = 330\text{A}$		1.32	1.57	V
$R_{th(j-c)}$	Thermal resistance junction to case	Single side cooled per chip			0.35	°C/W
$R_{th(c-s)}$	Thermal resistance case to sink	Single side cooled per chip			0.20	°C/W
V_{ISO}	Isolation voltage	50Hz, RMS, $t = 1\text{min}$			3000	V
F_M	Mounting torque - copper plate (M6)		4		6	N·m
	Mounting torque - terminal (M5)		2.5		4.5	N·m
T_{stg}	Storage Temperature		-40		150	°C
T_j	Operating Temperature		-40		150	°C
W_t	Weight			120		g
Outline	M01G					

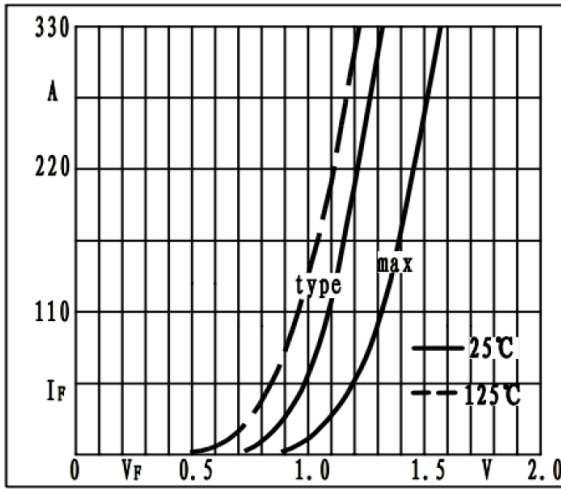

Fig1. Forward characteristics

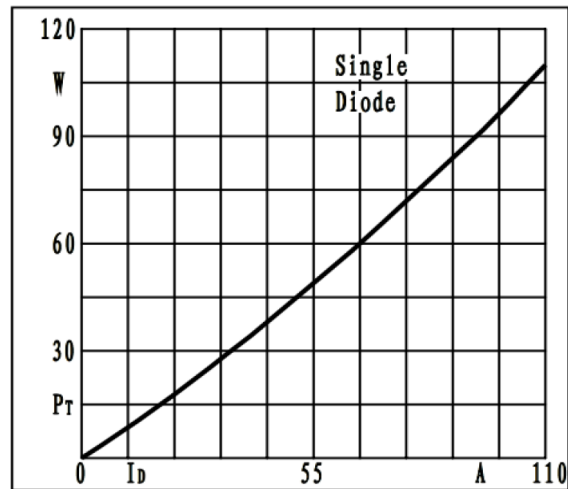

Fig2. Power dissipation

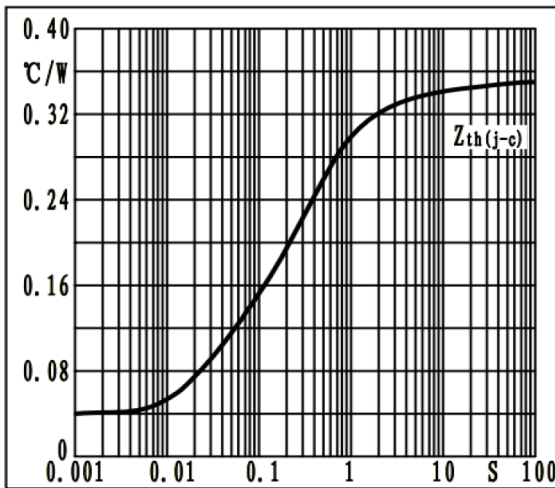

Fig3. Transient thermal impedance

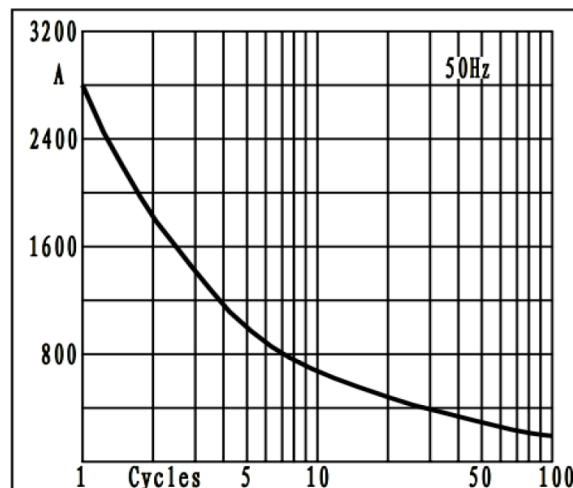

Fig4. Max non-repetitive forward surge current

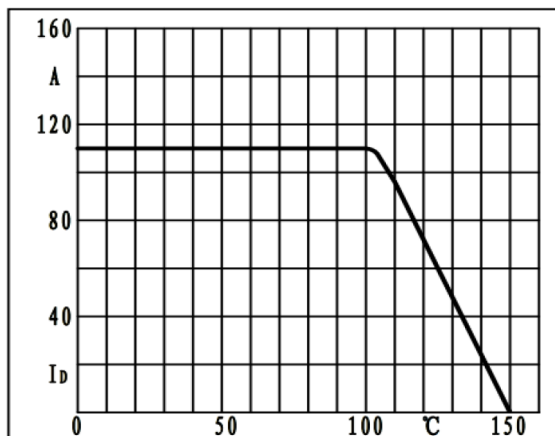
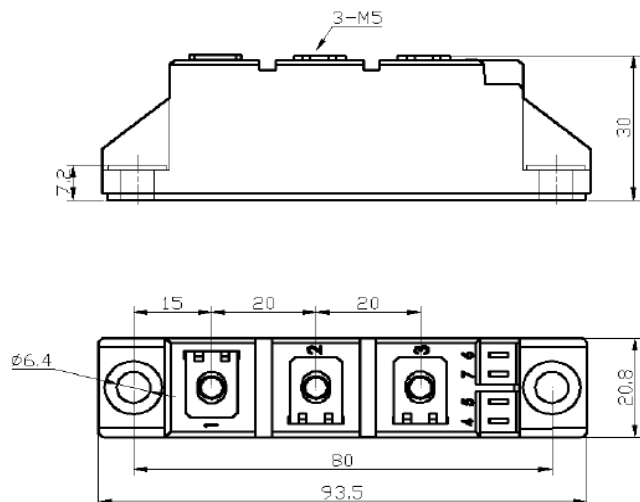

Fig5. Forward current derating curve



(dimensions in mm)

S.CO.M.E.S. Srl

Via Enrico Mattei, 6/8 - 26283 - Castiglione d'Adda (LO) - Italy

Phone: +39 0377 901243 Fax: +39 0377 900206

Scomes Srl reserves the right to change any specification without notice